

18 inch Subwoofer

- **High Excursion**
- **Very Low Distortion**
- **No Stray Magnetic Fields**

Nominal Diameter 18 inches (477 mm)
 Nominal Impedance (Z) 4 Ohms
 Sensitivity, 1W/1m (E) 86 dB @ 100 Hz
 Power Capacity, RMS (Pe) 800 W
 Power Capacity, Peak 3200 W
 Frequency Range (-10dB) Fo - 1.5 kHz
 Minimum Impedance 5 ohms
 Voice Coil Diameter 99.2 mm
 Voice Coil Winding Length (h) 25.4 mm
 Voice Coil Number of Layers (n) 1
 Voice Coil Former Material Glass composite
 Voice Coil Wire Composition Aluminum Ribbon
 Magnetic Material Neodymium radial
 Stray Flux Shielding Inherent
 Magnetic Gap Depth (He) 50.8 mm
 Cone Material Aluminum
 Surround Material Injector molded rubber
 Polarity, Outward Motion Positive voltage on (+) termin
 Net Weight 19.7 kg
 Maximum Excursion 75 mm peak to peak

Thiele / Small Parameters

Resonant Frequency (Fo) - Fs 20 Hertz
 Voice Coil DC Resistance - Re 3.1 ohms
 Total Q - Qts 0.47
 Mechanical Q - Qms 7.7
 Electrical Q - Qes 0.50
 Equivalent Volume of Air - Vas 322 L
 Radiating Piston Area - Sd 1164 cm²
 Xmax 38 mm peak to peak

Electrical / Mechanical Parameters

Flux Density x Length - BL 17 Tesla-meters
 Compliance - Cms 170 μm/N
 Total Mass - Mms 400 grams

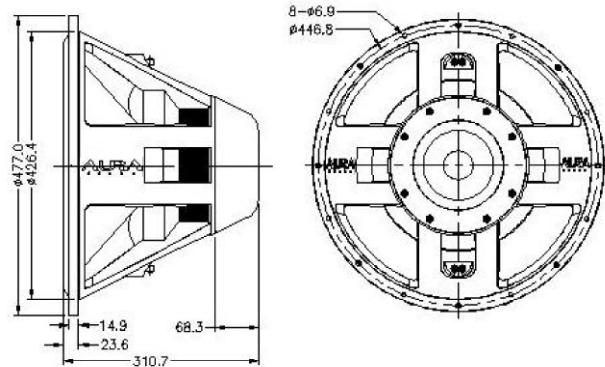

Frequency Response (1W, 1m)

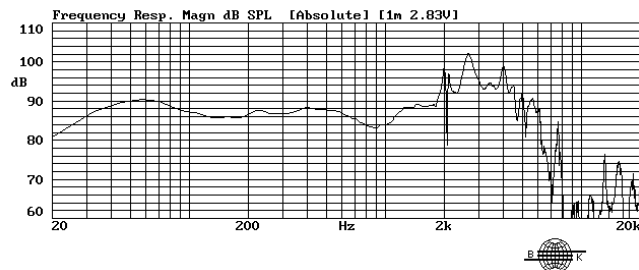

Impedance

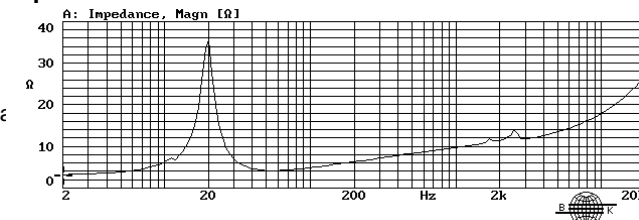

Distortion (1W, 1m)

